

PERFORMANCES

- High accuracy
- High stability
- Fast transients
- High inrush current facilities
- Wide bandwidth
- Very low distortion
- Quadrant change without transition
- Very low output impedance

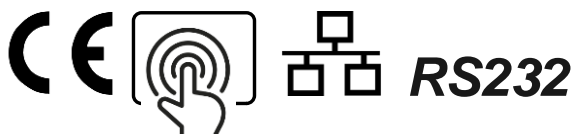

APPLICATIONS

- One insulated outputs
- AC, AC+DC, DC
- Avionic networks 300-800-1200Hz
- Industrial networks 50-60 Hz
- Tests in accordance with standards ABD100.1.8 / MIL-STD-704
- Disturbed networks
- AC or DC motor simulation
- Non-linear loads
- Harmonics generation



Non contractual picture

DESCRIPTION

- PUISSANCE+ amplifiers are real “4 quadrants” power amplifiers, single-phase, operating in voltage regulation:
 - An analog input receives a “pilot” signal whose amplitude is $0 \sim \pm 10$ V (7.07 VRMS) peak, coming from amplifier internal synthesizer or from an external synthesizer,
 - After insulation, the equipment amplifies this signal depending on the selected range, with a very short propagation delay.
 - On all our amplifiers, two analog and insulated outputs return images of voltage and current at the output of the equipment with amplitude $0 \sim \pm 10$ V peak.
- The linear technology used for these amplifiers allows:
 - A high dynamic, a very low distortion on a wide frequency range and a large bandwidth
 - To provide power peaks up to 4 times its nominal power
 - An easy integration for “Real-Time” or “Power Hardware In the Loop” applications with simulators
 - A power factor between +1 (source mode) and -1 (sink mode).
- Entirely self-sufficient with its local control on touch screen, they can be controlled remotely from a supervisor system via an Ethernet or RS232 link for easy integration in a complex test system.

FEATURES OF 10 KVA AMPLIFIERS

OUTPUT	Voltage and current in AC (SOURCE)	Range 130V	Range 200V	Range 260V	Range 400V
	Rated AC power (VA)	10 000			
	Rated AC voltage (VRMS)	130	200	260	400
	Permanent AC current (ARMS)	77	50	38	25
	Peak AC current (A peak) (1)	230	150	115	75
	Voltage and current in DC (SOURCE)	Range 180V	Range 280V	Range 360V	Range 560V
	Rated DC power (W)	7 000			
	Rated DC voltage (VDC)	±180	±280	±360	±560
	Permanent DC current (ADC)	39	25	19	12
	Peak DC current (A peak) (1)	97	62	47	30
	Voltage and current in AC (SINK) (2)	Range 130V	Range 200V	Range 260V	Range 400V
	Rated AC power (VA)	2 500			
	Continuous AC current (ARMS)	19	13	10	6
	Peak AC current (A peak) (1)	57	39	30	18
	Voltage and current in DC (SINK)	Range 180V	Range 280V	Range 360V	Range 560V
	Rated DC power (W)	4 000			
Continuous DC current (ADC)	22	14	11	7	

Note (1): these values are for duration of less or equal to one second. Overcurrent can be higher on request (i.e. 4 times during 5 seconds).

Note (2): the SINK mode corresponds to a power factor of -1 (phase shift of 180 ° between the current and voltage).

INCREASE IN THE TOTAL OUTPUT POWER

Given that the architecture of our amplifiers, it is possible to transform a power amplifier 10 kVA in a 15kVA power amplifier. This, the addition of power parts, made mandatory by a return of the amplifier to our factory, allows deferring part of the investment.

COMMERCIAL REFERENCE

PA-10000-AC/DC-4Q-400V-77A-4G

FEATURES OF 15 KVA AMPLIFIERS

OUTPUT	Voltage and current in AC (SOURCE)	Range 130V	Range 200V	Range 260V	Range 400V
	Rated AC power (VA)	15000			
	Rated AC voltage (VRMS)	130	200	260	400
	Permanent AC current (ARMS)	115	75	58	38
	Peak AC current (A peak) (1)	345	225	174	114
	Voltage and current in DC (SOURCE)	Range 180V	Range 280V	Range 360V	Range 560V
	Rated DC power (W)	10600			
	Rated DC voltage (VDC)	±180	±280	±370	±570
	Permanent DC current (ADC)	59	38	29	19
	Peak DC current (A peak) (1)	147	95	72	47
	Voltage and current in AC (SINK) (2)	Range 130V	Range 200V	Range 260V	Range 400V
	Rated AC power (VA)	3750			
	Continuous AC current (ARMS)	29	19	14	9
	Peak AC current (A peak) (1)	87	57	42	27
	Voltage and current in DC (SINK)	Range 180V	Range 280V	Range 360V	Range 560V
	Rated DC power (W)	6000			
Continuous DC current (ADC)	33	21	16	11	

Note (1): these values are for duration of less or equal to one second. Overcurrent can be higher on request (i.e. 4 times during 5 seconds).

Note (2): the SINK mode corresponds to a power factor of -1 (phase shift of 180 ° between the current and voltage).

COMMERCIAL REFERENCE

PA-15000-AC/DC-4Q-400V-115A-4G

FEATURES OF 20 KVA AMPLIFIERS

OUTPUT	Voltage and current in AC (SOURCE)	Range 130V	Range 200V	Range 260V	Range 400V
	Rated AC power (VA)	20000			
	Rated AC voltage (VRMS)	130	200	260	400
	Permanent AC current (ARMS)	154	100	77	50
	Peak AC current (A peak) (1)	462	300	231	150
	Voltage and current in DC (SOURCE)	Range 180V	Range 280V	Range 360V	Range 560V
	Rated DC power (W)	14100			
	Rated DC voltage (VDC)	±180	±280	±370	±570
	Permanent DC current (ADC)	79	51	38	25
	Peak DC current (A peak) (1)	198	127	95	62
	Voltage and current in AC (SINK) (2)	Range 130V	Range 200V	Range 260V	Range 400V
	Rated AC power (VA)	3750			
	Continuous AC current (ARMS)	29	29	29	29
	Peak AC current (A peak) (1)	87	87	87	87
	Voltage and current in DC (SINK)	Range 180V	Range 280V	Range 360V	Range 560V
	Rated DC power (W)	6000			
Continuous DC current (ADC)	33	33	33	33	

Note (1): these values are for duration of less or equal to one second. Overcurrent can be higher on request (i.e. 4 times during 5 seconds).

Note (2): the SINK mode corresponds to a power factor of -1 (phase shift of 180 ° between the current and voltage).

COMMERCIAL REFERENCE

PA-20000-AC/DC-4Q-400V-154A-4G

FEATURES OF 24 KVA AMPLIFIERS

OUTPUT	Voltage and current in AC (SOURCE)	Range 130V	Range 200V	Range 260V	Range 400V
	Rated AC power (VA)	24000			
	Rated AC voltage (VRMS)	130	200	260	400
	Permanent AC current (ARMS)	185	120	92	60
	Peak AC current (A peak) (1)	555	360	276	180
	Voltage and current in DC (SOURCE)	Range 180V	Range 280V	Range 360V	Range 560V
	Rated DC power (W)	16900			
	Rated DC voltage (VDC)	±180	±280	±370	±570
	Permanent DC current (ADC)	94	61	46	30
	Peak DC current (A peak) (1)	235	152	115	75
	Voltage and current in AC (SINK) (2)	Range 130V	Range 200V	Range 260V	Range 400V
	Rated AC power (VA)	3750			
	Continuous AC current (ARMS)	29	29	29	29
	Peak AC current (A peak) (1)	87	87	87	87
	Voltage and current in DC (SINK)	Range 180V	Range 280V	Range 360V	Range 560V
	Rated DC power (W)	6000			
Continuous DC current (ADC)	33	33	33	33	

Note (1): these values are for duration of less or equal to one second. Overcurrent can be higher on request (i.e. 4 times during 5 seconds).

Note (2): the SINK mode corresponds to a power factor of -1 (phase shift of 180 ° between the current and voltage).

COMMERCIAL REFERENCE

PA-24000-AC/DC-4Q-400V-185A-4G



COMMON FEATURES OF ALL AMPLIFIERS

OUTPUT	Output			
	Type	Direct (without transformer)		
	Voltage accuracy			
	Typical	0,1% of range + 0,1% of programmed value		
	Resolution	12 bits		
	Current accuracy			
	Typical	0,1% of range + 0,1% of programmed value		
	Resolution	12 bits		
	Voltage distortion at full output power			
	Typical	< 0,3%		
	Max	< 0,7%		
	Voltage regulation for a mains variation of +6% / -10%			
	Max	< 0,1% of rated voltage		
	Voltage regulation for a current variation from 0 to 100%			
	Max	< 0,1% of rated voltage		
	Noise			
	Max RMS	0,02% of rated voltage		
	Max peak to peak	0,3% of rated voltage		
	Bandwidth			
	Full scale	DC – 5 kHz		
	Small signals at -3 dB	25 kHz		
	Variation with a square signal pilot			
	Rise time 10% / 90%	< 20 μ s		
	Fall time 10% / 90%	< 20 μ s		
	Transfer time	< 20 μ s		
	Transition from Q1 to Q4	< 10 μ s		
	Variation according temperature			
	Typical	50 ppm/°C		
	Max	100 ppm/°C		
	Stability after 15 minutes of operation			
Max	< 0,05% of rated voltage			
Insulation of the outputs versus case ground				
Measurement at 500 VDC	> 100 M Ω			
Accuracy of the measurements displayed on the touch screen				
Voltage measurement	0,3% of range + 0,3% of measure			
Current measurement	0,3% of range + 0,3% of measure			

MAINS	Mains network				
	Number of phases	3 Phases + Earth without Neutral			
	Voltage	400 VRMS -10% +6%			
	Frequency	47 - 63 Hz			
	Mains current at full output power	PA-10K	PA-15K	PA-20K	PA-24K
	Max (ARMS / phase)	21	32	42	64
	Protection	Magneto thermal breaker			
	Inrush current	Limited to 2 x Max current			
	Dielectric strength of the mains input versus the output connected to the case ground				
	Measurement at 1500VRMS / 50Hz	Current < 10 mA			

INPUT	Input signal amplitude	
	Insulation	> 10 MΩ (1)
	Voltage for full output scale	7,07 VRMS / ± 10V peak
	Max. voltage	± 15 V peak
	Input impedance	10 kΩ
	Input signal frequency	
	Fundamental	DC – 5kHz
	Harmonics (small signals)	Max 50 kHz

MECHANICAL AND ENVIRONMENTAL	Metallic parts treatment	
	Frame	Aluminum painted RAL7021
	Slides and rear side	Aluminum painted RAL7035
	Dimensions and weight	
	Width	800 mm
	Depth (connectors excluded)	800 mm
	Height	2010 mm (38U)
	Weight	600 kg
	Temperature and humidity	
	Storage temperature	-10°C à +85°C
	Operating temperature	+0°C à +50°C
	Relative humidity	10% - 90% non-condensing
	Sound level (fans at full speed)	
	Measured at 1 m of front panel	< 70 dBA
	Marking	
	Marking	CE
	Index of protection	IP30
	Protections	
	Against overload	Limitation of voltage (2)
	Against output short-circuit	Cut of the power stage (3)
Against overheating	Cut of the power stage (4)	

- 1) The analog inputs are isolated from power outputs.
- 2) In case of temporary overload the voltage decreases to limit the current.
- 3) The output is switched off and will have to be reactivated by the touch screen or an external command.
- 4) A temperature sensor is placed on every power part. It switches off the output of the amplifier in case of overheating.

INCREASE THE DC VOLTAGE:

To increase the available output DC voltage, it is possible to link several amplifiers IN SERIES:

- Amplifiers use the same range,
- The same pilot signal is sent on the amplifiers inputs,
- The maximum voltage is thus the sum of the voltages of each amplifier (it is however MANDATORY to limit the total voltage to 1200 VDC).

INCREASE THE CURRENT IN DC:

To increase the available DC current, it is possible to link several amplifiers IN SERIES:

- Amplifiers use the same range (130 V for example),
- The same pilot signal is sent on the amplifiers inputs,
- The permanent maximum voltage is the sum of the voltages of each amplifier, either 3x180V = 540 VDC in our example,
- The maximum current is then the current of the 130VDC range or 39 ADC in steady state (for a 10kVA power amplifier) instead of 12 ADC when using 400V range.

4 QUADRANTS

Amplifiers operate in voltage regulation with current limitation: in case of temporary overload the voltage decreases to limit the current.

In "Q1" and "Q3" areas, the amplifier behaves in "GENERATOR or SOURCE": the instantaneous power is positive.

In "Q2" and "Q4" areas, the amplifier behaves in "ABSORBER or SINK": the instantaneous power is negative.

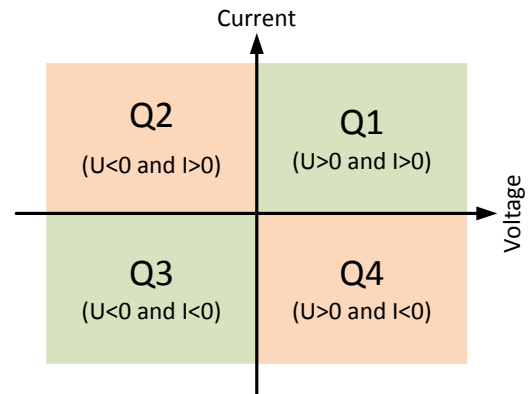

On a time scale, with voltage in Blue trace, current in Red trace, power in Green trace:

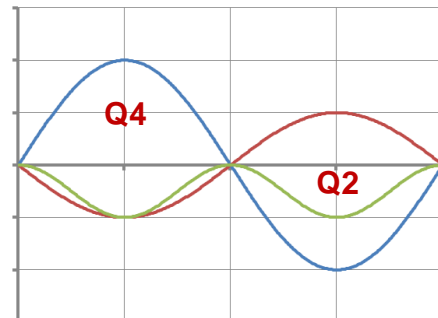

INTERNAL CONSTITUTION

The amplifier includes:

- one AF generator,
- one analog input,
- one power output,
- two outputs "Image"

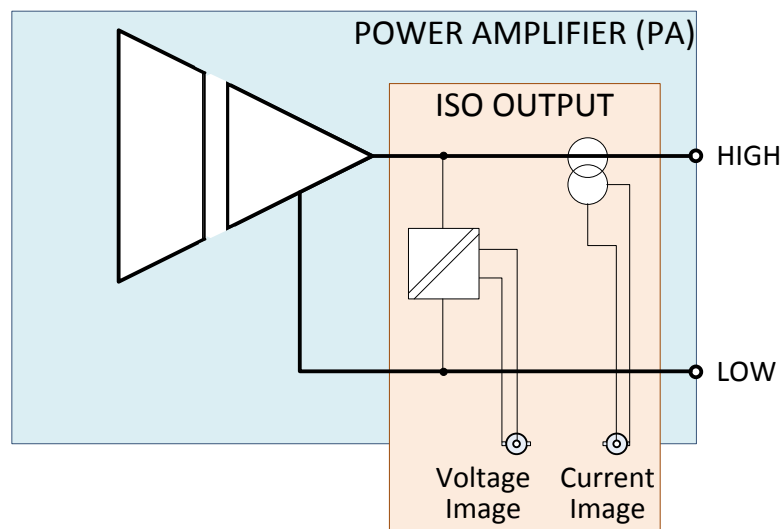

The outputs "Voltage Image" and "Current Image" are insulated from power outputs.

OPTIONS

“PA-10-24K-ACQ”: add a power analyzer for each phase

It allows measurements of frequency, voltage, current, power, distortion and a frequential analysis (Fourier Form Transform).

More description is in its technical sheet “FT-Carte ACQ-EN”

“PA-10-24K-SR”: customized output voltage ranges

Output voltage ranges can be modified – Please consult us.

“PA-10-24K-SYNU”: add an internal AF generator

It allows waveform generation for specific waveforms or to implement signals with a predefined distortion.

More description is in its technical sheet “FT-Carte SYNU-EN”

“PA-10-24K-WBW”: bandwidth extended for “small signals”

Increase from 25 kHz to 50 kHz (measurement at -3dB) in voltage regulation

“PA-10-24K-L100”: resistive load

A resistor is inserted between output of the amplifier and use. It increases absorption capability. See details on page 13.

“PA-10-24K-MAINS”: customized mains input

An adaptation of mains input to your network can be proposed - Please consult us.

BANDWIDTH “small signals”

Blue trace:

In voltage regulation bandwidth at -3dB is 25 kHz.

Green trace:

In voltage regulation, with “PA-10-24K-WBW” option, bandwidth at -3dB is increased to 50 kHz.

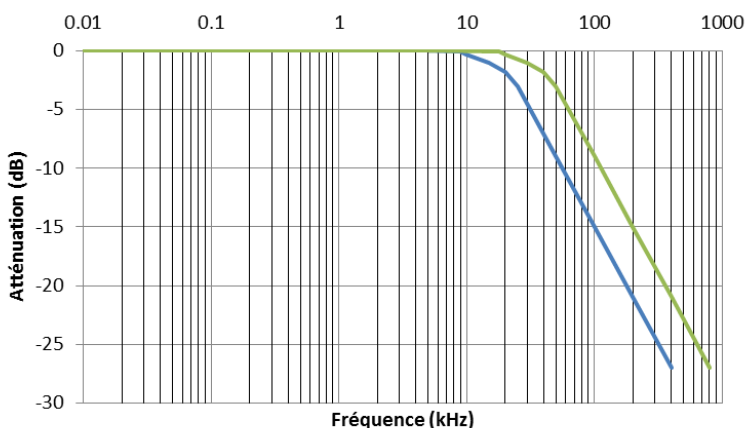

PERMANENT OPERATION IN AC

These diagrams express the relationship between the current and the voltage for 1 and -1 power factor (full generation and full absorption). X-coordinates express the voltage as a percentage of the range. Y-coordinates express the current percentage of the rated current of the range.

Continuous operation is allowed “inside” diagrams. In generation or absorption limitations are due to the heating of the power transistors. Operation 'on the outside' diagrams will result in:

- an immediate switch-off by over-current protection if current is above the limits,
- a break after a delay by thermal protection in case of overheating of the power parts.

Amplifier 10 kVA

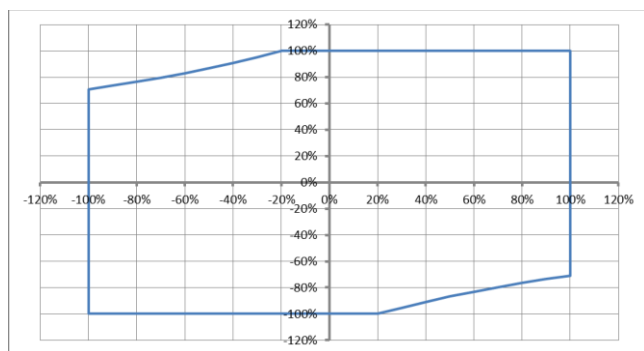

Amplifier 15kVA

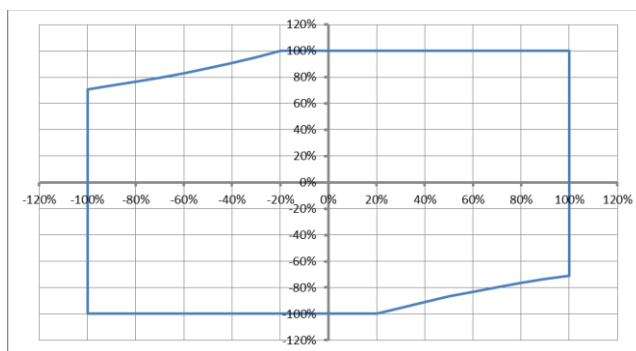

Amplifier 20 kVA

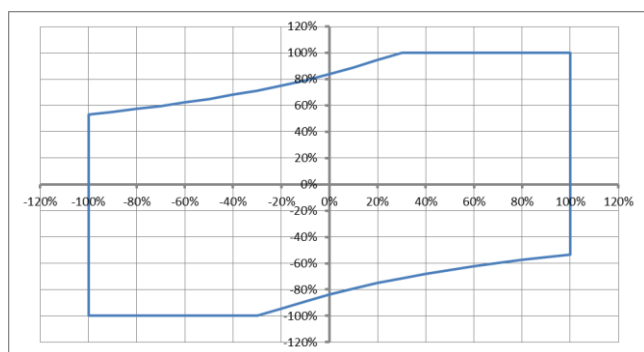

Amplifier 24kVA

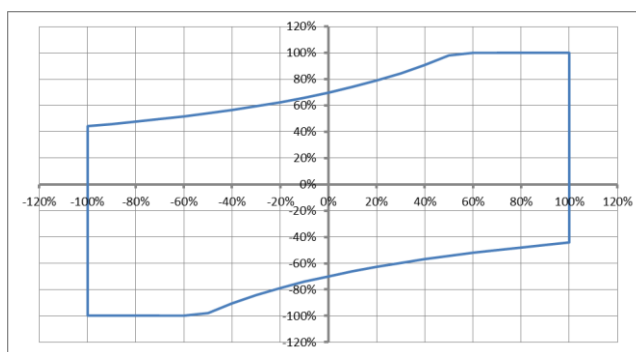

OPERATION IN AC REGARDING POWER FACTOR

These diagrams express the relationship between the current and the voltage for a factor of power ranging from -1 to 1. X-coordinates express the voltage as a percentage of the range. Y-coordinates express the current percentage of the rated current of the range.

Continuous operation is allowed “inside” diagrams. In generation or absorption limitations are due to the heating of the power transistors. Operation 'on the outside' diagrams will result in:

- an immediate switch-off by over-current protection if current is above the limits,
- a break after a delay by thermal protection in case of overheating of the power parts.

Blue line, voltage and current are in phase.

Red line, phase shift between current and voltage is $90^\circ (\pi / 2)$.

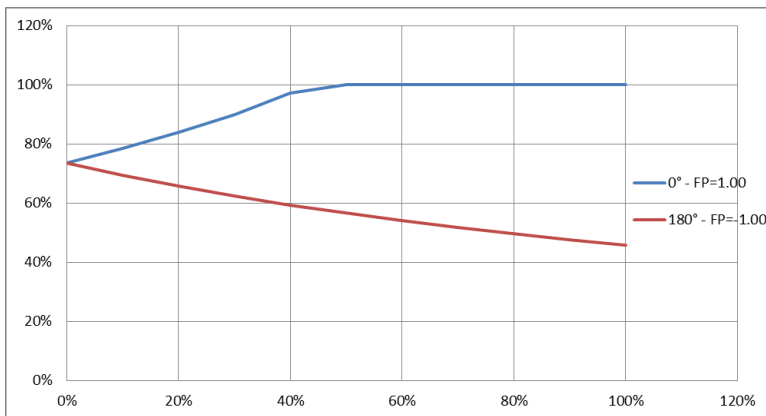
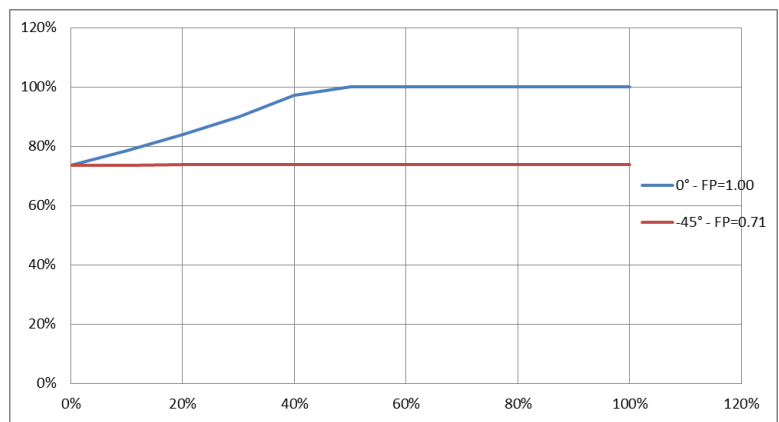
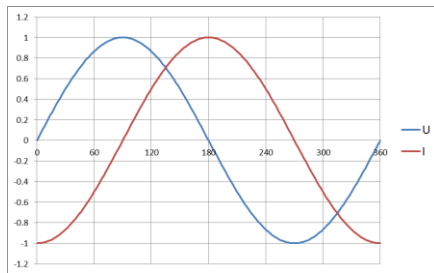

Blue line, voltage and current are in phase.

Red line, phase shift between current and voltage is $180^\circ (\pi)$.

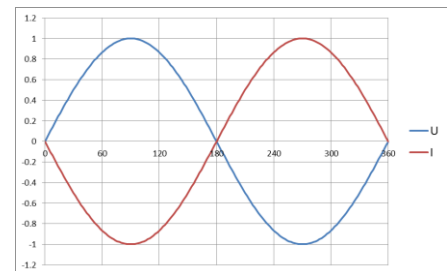

PERMANENT OPERATION IN DC

These diagrams express the relationship between the current and the voltage for a factor of power ranging from -1 to 1. X-coordinates express the voltage as a percentage of the range. Y-coordinates express the current percentage of the rated current of the range.

Continuous operation is allowed “inside” diagrams. In generation or absorption limitations are due to the heating of the power transistors. Operation 'on the outside' diagrams will result in:

- an immediate switch-off by over-current protection if current is above the limits,
- a break after a delay by thermal protection in case of overheating of the power parts.

Amplifier 10 kVA

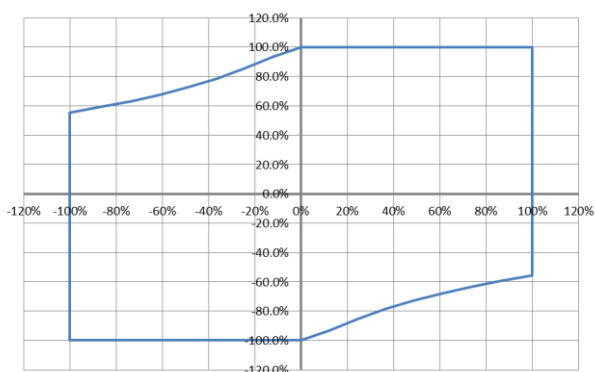

Amplifier 15kVA

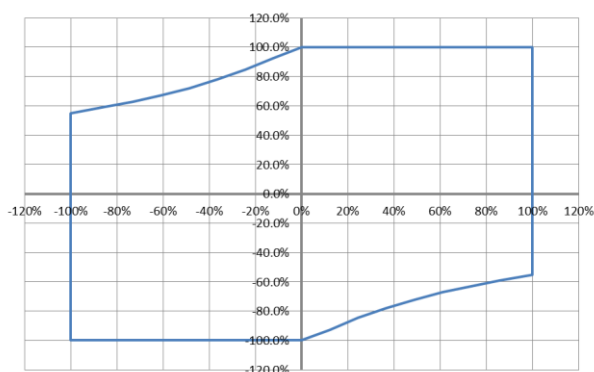

Amplifier 20 kVA

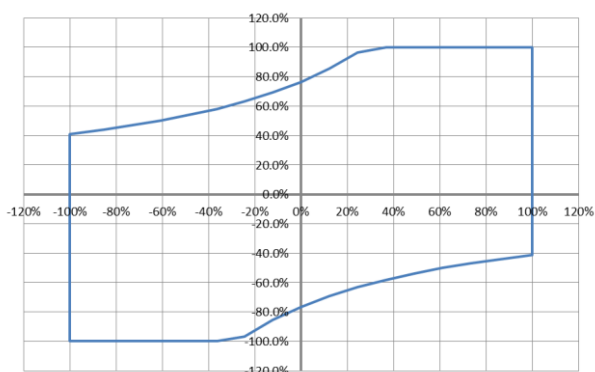

Amplifier 24kVA

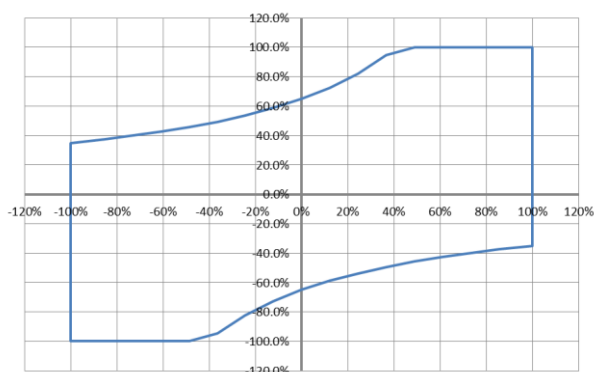

OPERATION WITH “RESISTIVE LOAD” (option PA-10-24K-L100)

The resistive load increases absorption capacity in quadrants “Q2” or “Q4” (see diagram explaining quadrants in page 8 of this document).

The diagram is:

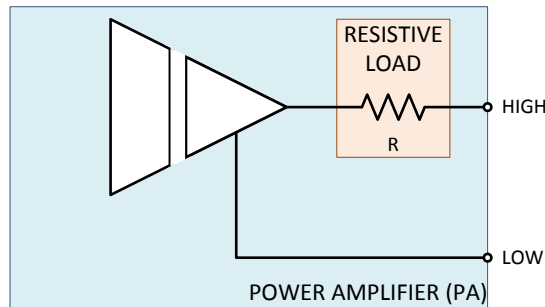

Resistor “R” can have two different values adapted to amplifier power.
The dissipated power by resistive load is around 15kW max.

Example of operating areas on 15kVA amplifier

Red trace = without resistive load
Green trace = with resistive load 8 ohms

In range “400V”, use of resistive load allows absorption of 100% in the quadrants “Q2” and “Q4”.

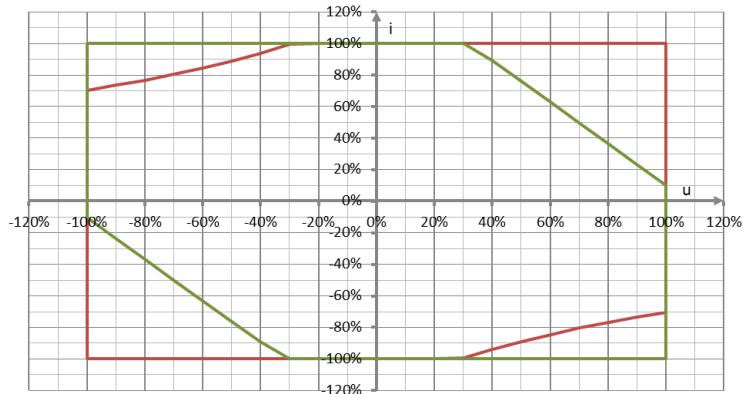

REMOTE AN AMPLIFIER USING OUR SOFTWARE SUITE OPS

Puissance + software suite OPS allows easy control of amplifiers.

The OPS1 software allows to generate specific waveforms and to view waveforms downloaded from acquisition cards (when the “Power Analyzer” option is installed).

The “SPC” library allows setting periodic waveforms with built-in distortion. The amplitude and phase of each harmonic, rank 2 to rank 500 can be programmed. A continuous component can also be added.

Example of creating waveform:

- Harmonic rank 10 = 10%
- Harmonic rank 20 = 10%
- Harmonic rank 30 = 10%

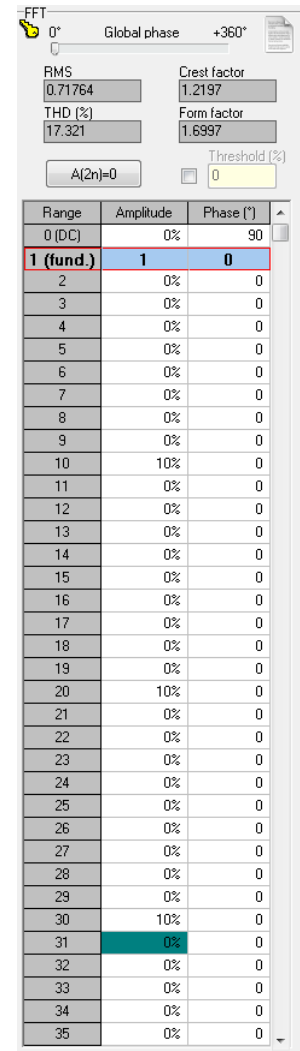

Range	Amplitude	Phase (°)
0 (DC)	0%	90
1 (fund.)	1	0
2	0%	0
3	0%	0
4	0%	0
5	0%	0
6	0%	0
7	0%	0
8	0%	0
9	0%	0
10	10%	0
11	0%	0
12	0%	0
13	0%	0
14	0%	0
15	0%	0
16	0%	0
17	0%	0
18	0%	0
19	0%	0
20	10%	0
21	0%	0
22	0%	0
23	0%	0
24	0%	0
25	0%	0
26	0%	0
27	0%	0
28	0%	0
29	0%	0
30	10%	0
31	0%	0
32	0%	0
33	0%	0
34	0%	0
35	0%	0



OPS3 software communicates with the amplifiers using an Ethernet or serial link.

The OPS3 software allows sending simple commands (ON / OFF, voltage range, maximum current) and to read and view simple information (status, voltage, current).

The OPS3 software is also used to send waveforms to the amplifier. It is also used to upload acquisitions made by the Power Analyzer if this option has been integrated.

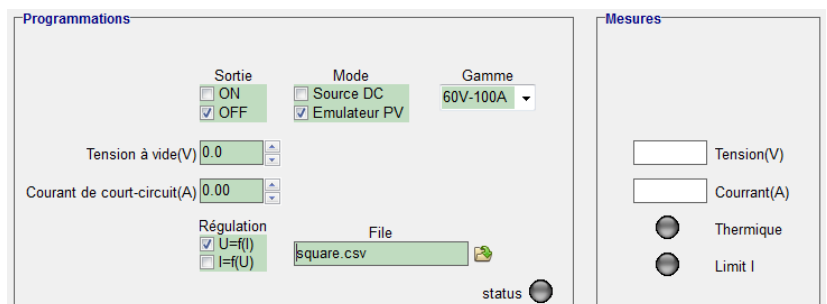

Programmations

Sortie: ON OFF

Mode: Source DC Emulateur PV

Gamme: 60V-100A

Tension à vide(V): 0.0

Courant de court-circuit(A): 0.00

Régulation: U=f(I) I=f(U)

File: square.csv

status:

Mesures

Tension(V)

Courant(A)

Thermique

Limit I

Specification subject to change without notice.